

# AP-KL3

INDOOR

LED Downlight

Dry/ Damp location

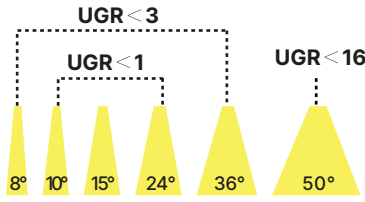

5 YEARS LIMITED WARRANTY INCLUDED | IP20 RATED & TESTED | IESNA LM-79 | IESNA LM-80 | DIMMABLE

- Low-Glare Performance (UGR Rated):** Engineered for visual comfort, delivering **Low UGR  $\leq 1 - 16$ , glare-free illumination** across narrow to wide beam options.
- Superior Light Quality:** Equipped with CREE COB LEDs, CRI 90+, SDCM <3, and tunable CCT from 2700K–6500K, ensuring accurate color rendering and uniform illumination.
- Flexible Performance:** Power configurable from 10W to 20W, delivering up to 2940 lumens, with dimming options including non-dim, 0–10V, TRIAC, and DALI control.
- Customizable Design:** Offered in black, white, champagne gold, or chrome finishes, with optical accessories like honeycomb, diffusion, and linear spread filters.
- Durable & Reliable:** Constructed from ADC12 aluminum, IP20/IP54 rated,  $-20^{\circ}\text{C}$  to  $40^{\circ}\text{C}$  operating range, CE / UKCA / RoHS / cETLus/ Reach compliant, and backed by a 5-year warranty.

## Ordering Information

Date: \_\_\_\_\_  
 Project: \_\_\_\_\_  
 Type: \_\_\_\_\_

Quantity: \_\_\_\_\_  
 Note: \_\_\_\_\_

## Order Form Clear Form

### Luminaire | Example: AP-KL-3-10-A-27-R90-8D-DM-WH-RD-WH-HC

Series	Model	Length	Wattage	Voltage	CCT	CRI	Beam Angle	Dimming	Finish	Reflector	Reflector Color	Accessories	Trim
AP	KL	3 Ø75	10 10W	A 120-277V AC	27 2700K	R90 >Ra90	8D 8° <sub>UGR 3</sub>	— None	WH White	RD Round	WH White	HC Honeycomb	ST Standard
			12 12W		30 3000K		10D 10° <sub>UGR 1</sub>	DM 0-10V	BK Black	PH Pin Hole	BK Black	LS Linear Spread Filter	TL Trimless
			15 15W		35 3500K		15D 15° <sub>UGR 1</sub>	TRI TRIAC		OV Oval	GD Gold	DF Diffusion Filter	
			20 20W		40 4000K		24D 24° <sub>UGR 3</sub>	DL DALI			MR Mirror		
					CCT CCT Tuneable		36D 36° <sub>UGR 1</sub>	BL Bluetooth			BC Black Chrome		
							50D 50° <sub>UGR 10</sub>						

**Housing**

- NCMP75** New Construction Mounting Plate
- IC75** IC Rated Housing

### Warranty Notes & Disclaimer

Malfunction and damage to product due to incompatible dimming system or misuse will not be covered under warranty. Consult Green Image Tech for recommended drivers. If the fixture has an option to be installed with a dimming control system, consult a dimming system manufacturer with minimum load before installing. Green Image Tech reserves the right, at its sole discretion, at any time and without notice, to make design changes to any of our products. Consult Green Image Tech website for most updated documentation.

# AP-KL3

INDOOR

LED Downlight

Dry/ Damp location

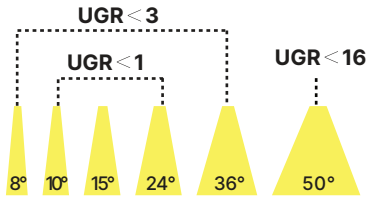

5 YEARS LIMITED WARRANTY INCLUDED | IP20 RATED & TESTED |   IESNA LM-79 | IESNA LM-80 |  DIMMABLE

## Performance

Model	Wattage	Efficacy	Fixture Output	CRI	Size
AP-KL3	10 - 20 W	55 - 75 lm/W	550 - 1,500 lm	>90	Ø75

## Application

Environment	Indoor, Dry / Damp, IP20 (Standard) / IP54 (Optional)
Mounting	Recessed Ceiling Mount (Spring Clip)
Protection Class	Class II
Impact Resistance	IK03
Working Temperature	-20° ~ +40°C
Weight	N/A
Material	Fixture: Die-cast Aluminum Housing   Lens: Optical PC / Tempered Glass
Finish	Powder-Coated White or Black

## Electrical

Power Supply	120-277V AC, 50/60 Hz
Control	Non-Dimmable / 0-10 V Dimming / TRIAC / DALI
Driver Type	Remote Constant-Current Driver
Surge Protection	N/A
Power Factor Correction (PFC)	> 0.9
Total Harmonic Distortion (THD)	< 15 %

## Luminaire Construction

LED Light Source	2700 K / 3000 K / 3500 K / 4000 K / 2700 – 6500 K (Tunable), CRI (Ra): 90+
Optional Feature	Honeycomb Louver, Linear Spread Filter, Diffusion Lens, Multiple Reflector Finishes
Installation	Recessed Ceiling Mount (Spring Clip) — Cut-out: Ø55 mm / Ø75 mm / Ø95 mm
Warranty & LED Life	5 years limited warranty. Estimated life of 50,000 hours
Beam Angle	AP-KL3 – UGR <1 (10°, 15°, 36°), UGC <3 (8°, 24°), UGR <16 (50°)

# AP-KL3

INDOOR

LED Downlight

Dry/ Damp location

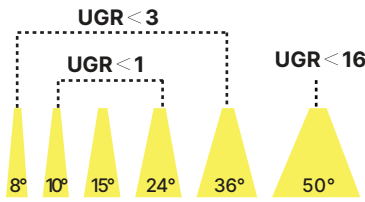

5 YEARS LIMITED WARRANTY INCLUDED | IP20 RATED & TESTED |   IESNA LM-79 | IESNA LM-80 | DIMMABLE 

## Specification

### Construction

- Precision-machined ADC12 aluminum housing with powder-coated finish
- Available frame colors: White or Black
- Reflector options: matte black, matte white, champagne gold, mirror, or black chrome
- Optical accessories: honeycomb, linear spread filter, diffusion filter
- Designed for recessed indoor applications with remote driver configuration

### Mounting

- Recessed mount with spring clip retention
- Ceiling cutout diameters:
  - AP-KL3:  $\varnothing$  2.95" | 75 mm
- Compatible with ceiling thickness 5 – 20 mm

### Warranty

- 5-year limited warranty
- LED lifetime  $\geq$  50,000 hours

### Optical Control & Accessories

- Reflector types: round / pinhole / oval ( $\pm$  10 % efficiency variance)
- Optional filters:
  - Honeycomb grid – reduces glare
  - Linear spread lens – widens beam
  - Diffusion lens – soft uniform output

### Environmental & Compliance

- IP20 (standard) / IP54 (optional)
- Indoor-only rated – not for wet or coastal environments

### Electrical

- Input Voltage: 120–277V AC, 50/60hz
- Driver Type: Remote constant-current
- Dimming: Non-dim / 0–10 V / TRIAC / DALI
- Power Factor:  $>$  0.9
- Operating Temperature:  $-20$  °C ~  $+40$  °C

### Optical Performance

- Light Source: CREE COB LED
- CRI 90 +, SDCM  $<$  3 steps
- CCT options: 2700 K / 3000 K / 3500 K / 4000 K / 2700–6500 K (tunable)
- Beam Angles:
  - AP-KL3 – 8° / 10° / 15° / 24° / 36° / 50°
- **UGR:  $\leq$  1 (narrow) /  $\leq$  3 (wide)**
- Efficacy: up to 120 lm/W (varies by beam and CCT)
- Sustainable design with Zhaga / NEMA connectivity

### Dimensions

- Fixture Diameter: 82 mm
- Fixture Height: 80 mm
- Cut hole:  $\varnothing$ 75 mm

### Applications

- Residential, retail, and hospitality spaces
- Museums, galleries, and high-end showrooms
- Offices, corridors, and reception areas
- Architectural accent and task lighting

## Features

Provide enough light for users without the need for additional wall lights

### AP-KL Downlight

Less shadow on face

No additional wall vanity lights

Deep anti-glare High efficiency

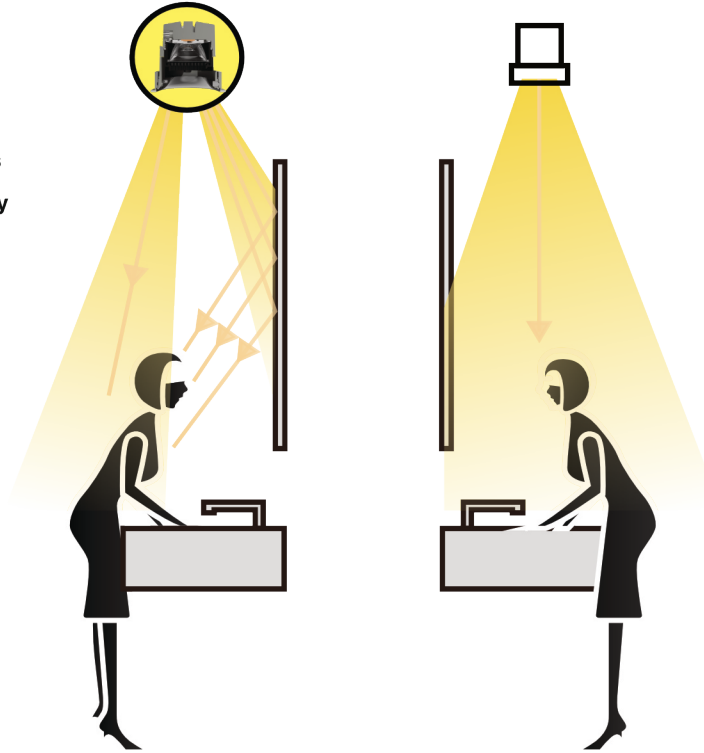

Ordinary Downlight

Single light source with several dark areas,  
prone to creating uneven facial lighting effects

### Patented Lens Design

Naked-eye visible anti-glare optical technology

enables healthy and comfortable lighting conditions

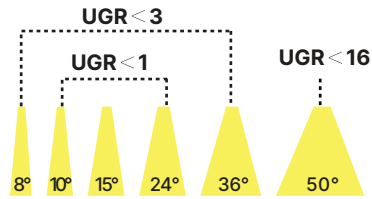
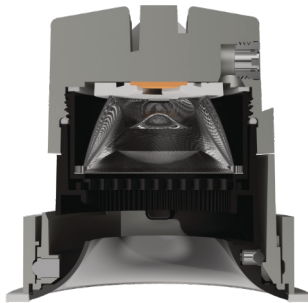

## Dimensions

### Fixture - AP-KL3

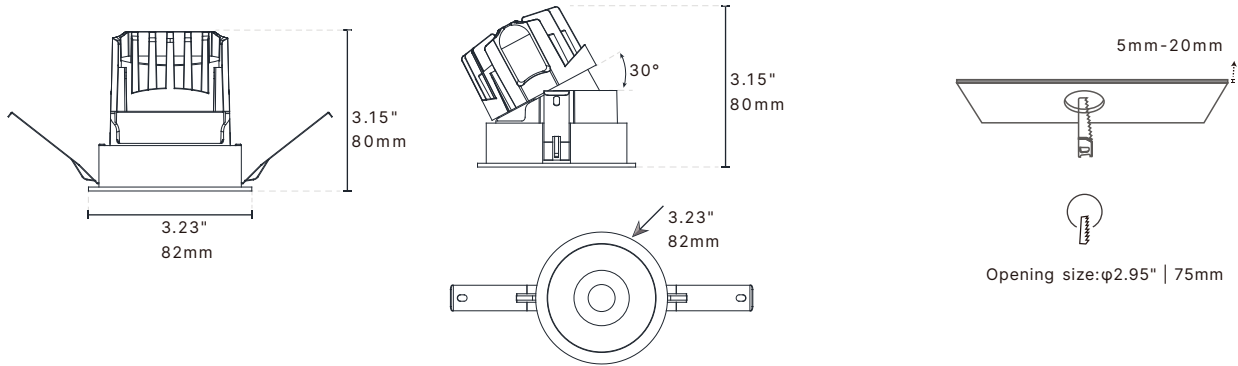

## AP-KL3 Beam Angle

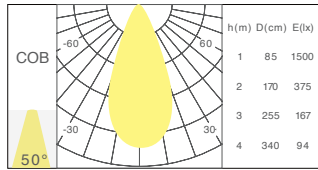
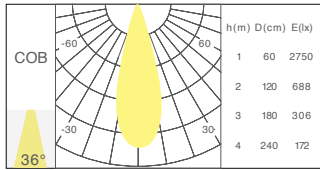
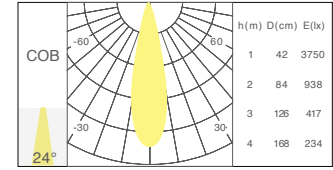
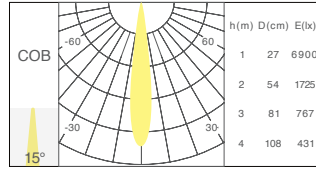
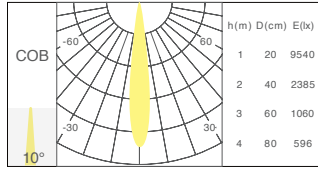
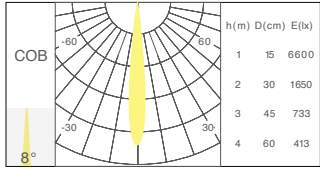

## AP-KL3 CCT Tuneable Beam Angle

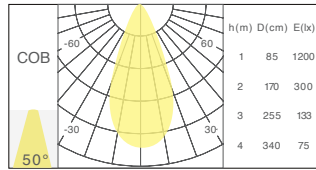
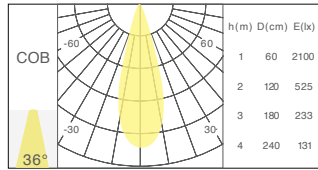
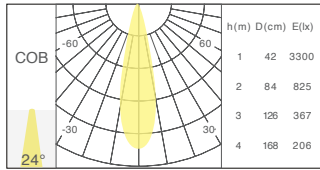

### Frame Colour



Black



White

### Reflector Type



Round



Pin hole



Oval

### Reflector Colour



Matte black



Matte white



Champagne Gold



Mirror



Black chrome

### Optical Accessory



Honeycomb



Linear Spread  
Filter



Diffusion  
Filter

Housing

**NCMP75:** New Construction Mounting Plate

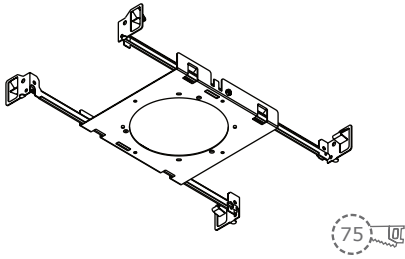

**New Construction Mounting Plate**

166 x 162 x 26mm

**IC75:** IC Rated Housing

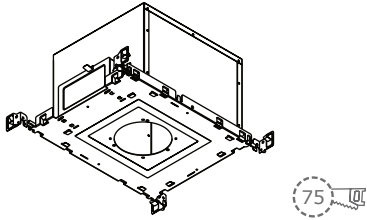

**Right Insulated Airtight**

350 x 277 x 207mm